

microglue®

228 Owner's Manual

(2 channels, 4 events per channel 4 outputs per channel)



GMS

1310 Redwood Way, Suite B.
Petaluma California, 94954 USA Phone: 707 285-3392 FAX: 707 285-3399
e-mail: sales@microglue.com
Edition 12-05-14



1310 Redwood Way, Suite B.
Petaluma, CA 94954 USA
Tel. 707 285-3392 Fax 707 285-3399
E-mail: sales@microglue.com
Web Site: www.microglue.com

Welcome:

Thank you for purchasing your **microglue**[®] control system and welcome to the next level in gluing technology. **microglue**[®] is a high-speed, precision glue control system that offers greater productivity and reduced waste through ease of setup, improved process control, and reduced maintenance.

This manual is split into several headings. All parts of the manual are important for a thorough knowledge of the system and to insure you receive the greatest benefits. Different jobs may require moving the glue valves, opto sensor, encoder, or other components. It is strongly recommended that you read the installation section of this manual fully to become familiar with any requirements of all the components used during a job set up.

To insure that **microglue**[®] is a safe and productive addition to your operation for many years to come, please be sure to mount all components where they will not become entangled in moving parts of the machine. It is very important that rollers, gears, and other moving parts be properly guarded. Under no circumstances should **microglue**[®] be used on an improperly guarded machine or under other unsafe conditions.

The high performance glue applicator heads that have been provided with your system will function more efficiently if a few simple rules are observed—

- Never operate an applicator head dry.
- Use the manual purge button to prime the system before running a job.
- **Clean, clean, clean** all parts (heads, hoses, etc.) on a regular basis, preferably after each job.
- Insure that the glue is within its shelf life and is maintained at its correct temperature rating.
- Avoid coagulation and downtime—do not cross contaminate glues when changing types.

There is no “universal” glue suitable for every application. Your application may require some experimentation. All glues are affected by temperature changes, have limited shelf lives. It is important to work with your local supplier to insure that your glue is not only fresh but that it also correctly matches the application to achieve the desired results. Cold affects glue viscosity dramatically. Cold glue will not flow through the hoses and valves correctly. Maintain temperatures. If necessary, wrap the glue tank with a heating blanket.

TABLE OF CONTENTS

- Introduction
- Display Console Overview
- Display Console Back Overview
- Key Stroke Functions
- Set Up Routine
- Basic Operation
- Auxiliary Mode Operation
- Product And Batch Counter Operation
- Channel Operation
- Warranty Policy

Notes

| |
|--------------------|
| Serial Number |
| Date |
| Machine Brand/Type |
| Dealer |
| Installed by |

THIS DOCUMENT CONTAINS PROPRIETARY INFORMATION WHICH IS PROTECTED BY COPYRIGHT. ALL RIGHTS ARE RESERVED. NO PART OF THIS DOCUMENT MAY BE PHOTOCOPIED, REPRODUCED, OR TRANSLATED TO ANOTHER LANGUAGE WITHOUT THE PRIOR WRITTEN CONSENT OF GRAPHIC MACHINERY & SYSTEMS.

microglue[®] and **GMS[®]** are registered trademarks of Gluing Machinery & Systems, Inc.

INTRODUCTION

microglue[®] 228 is a full featured controller for dispensing glue and performing other distance based operations. The basic unit consists of a display unit, which prompts the user through the operating procedures. When the computer is first switched on it displays the software version then enters the auxiliary mode. **microglue**[®] is then ready for programming or operation.

The controller has 2 channels each with 4 events and there are 4 outputs per channel. Each channel can be programmed for four specific events such as a dot, stitch, or line gluing. **microglue**[®] makes use of an encoder and equations to provide automatic speed compensation during operation.

Notes:

1. Glue will squeeze outwards as the product is folded. To avoid getting glue on the machine during initial make ready, program the glue for the center of the desired area, increasing it to extend toward the edges of the contact area gradually as product is run. Note that this squeeze distorts the start and stop locations, which furthers the need to start with less glue and grow the pattern.
2. The encoder will increase count in both directions. Measure the opto lead with a ruler and use the arrow keys to program the value when applicable.
3. In cases where the opto must be mounted behind the glue valve (such as stream feeders, or commercial folders) feed the paper until the leading edge is directly under the optical sensor and measure the distance from where glue should be applied to the nozzle of the applicator valves. Use this distance as the start value and set the opto lead to zero.
4. The actual start location of the glue is the total of the *opto lead* and the *start at* values. A program with 1 inch and 3 inches for these respective values will perform the same as a program with 2 inches and 2 inches.
5. If a stitch on or stitch off is programmed too small and or the speed is high, **microglue**[®] will automatically switch to time based operation to insure that glue and gaps occur. This may cause the actual lengths to vary from those programmed.
6. For simplicity, examples in this manual assume inches have been selected for the units.

DISPLAY CONSOLE FRONT

Channel Keys

Push these keys to enable or disable each Channel

Channel Status LED's

To indicate Channel status

A= Active - = Enabled or O = Off

Opto LED's

To indicate when the Optical Sensors see the product

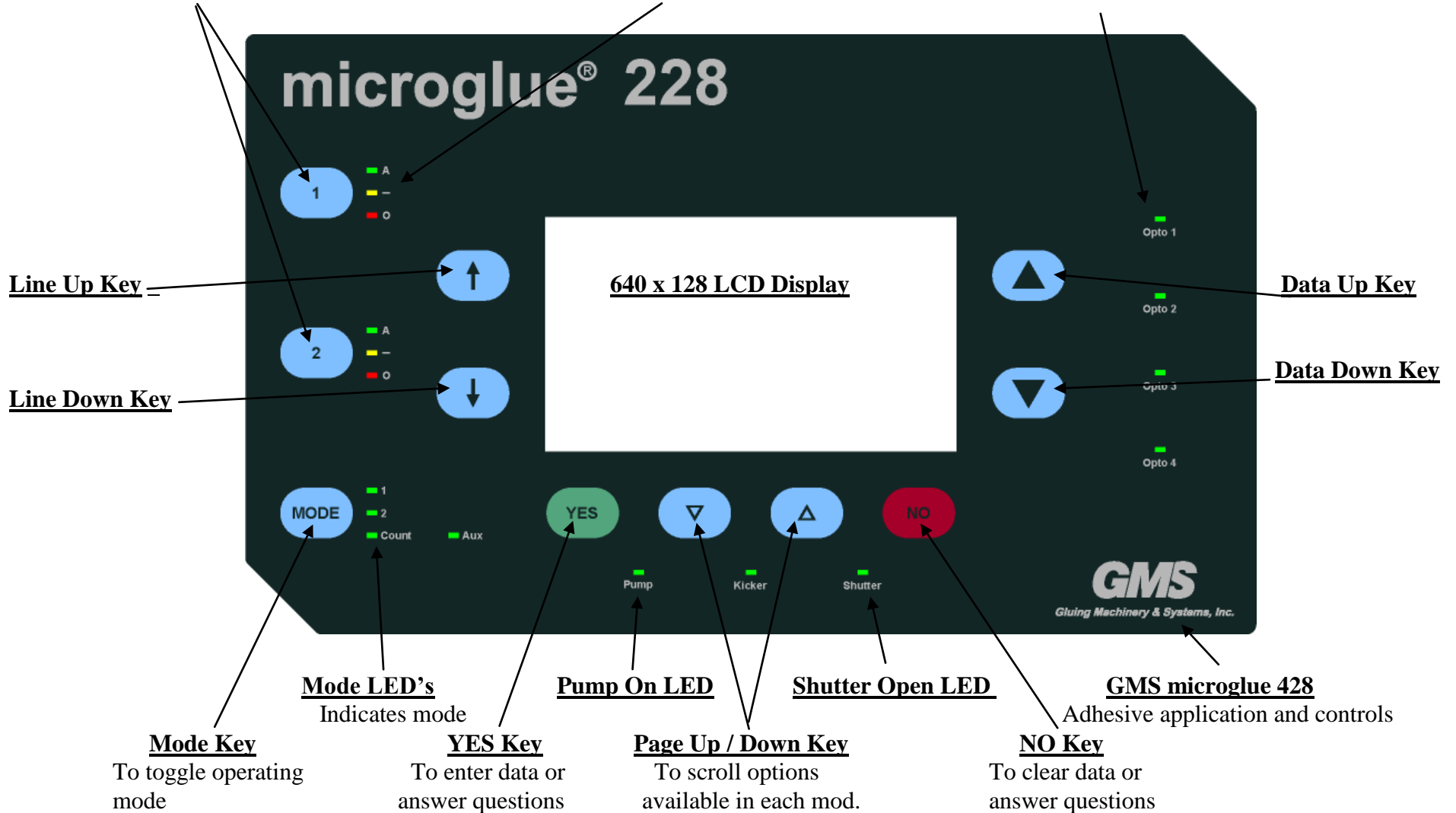

Line Up Key

Line Down Key

Mode Key

To toggle operating mode

Mode LED's

Indicates mode

YES Key

To enter data or answer questions

Pump On LED

Page Up / Down Key

To scroll options available in each mod.

Shutter Open LED

NO Key

To clear data or answer questions

GMS microglue 428

Adhesive application and controls

DISPLAY CONSOLE BACK

Channel 1 outputs
Variable current output

Channel 2 outputs
Variable current output



Encoder inputs
Encoders 1 & 2

Control outputs
Glue valve shutter
Pump & Batch Kicker

Optical Sensor Inputs
Optical Sensors 1 - 4

Proportional control output
0-10 VDC based on speed

Key Stroke Functions

YES

Yes key is used to answer direct questions identified by a “?”.

NO

No key is used to answer direct questions identified by a “?”.

MODE

Mode key is used to switch between the 4 channel and the Auxiliary and counter modes.

△

Page Up key allows you to scroll up through each screen available within each mode.

▽

Page Down key allow you to scroll down through screens available within each mode.

↑

Line up key moves the cursor (highlighted line) up one line within the screen being viewed.

↓

Line Down key moves the cursor (highlighted line) down on line within the screen being viewed.

▲

Data up key allows you to increase the value of the data on the line highlighted.

▼

Data Down key allows you to decrease the value of the data on the line highlighted.

1

Pressing the **1** key enables or turns off the outputs for channel one.

2

Pressing the **2** key enables or turns off the outputs for channel two.

SET UP ROUTINE

All **microglue**[®] 228 controllers are programmed in English and inches when shipped from the factory. It is only necessary to enter this routine if changes to either language, units of measure or purge frequency are required. Once this routine is entered, it must be completed prior to operation. After power on, press the **MODE** key while **microglue**[®] 228 displays the software version. **microglue**[®] 228 will prompt the following questions:

SET UP ROUTINE
CHOOSE LANGUAGES
AVAILABLE FOR USE.

INSTALL ENGLISH?

Press the **YES** or **NO** keys to accept or change which languages the system will display. Press **YES** if the English language will be used, **NO** if not.

Continue with this procedure for all offered languages. If no languages are selected, the cycle will start again. If more than one language was selected, you will be asked to choose a language to continue.

The next step after the language selection process is choosing which unit of measure you wish to use.

SET UP ROUTINE
CHOOSE A UNIT OF
MEASURE.

UNITS = IN:PSI ?

Press the **YES** or **NO** keys to accept or change which units the system will display. Press **YES** if inches will be used, **NO** if not.

Additional choices are millimeters or centimeters. If no unit of measurement has been selected, **microglue**[®] will cycle through the choices again. **microglue**[®] **does its internal calculation in inches, consequently when microglue is operating in metric, some least significant digit values will be skipped because of the math round off.**

The next step after unit selection is to set the encoder pitch.

SET UP ROUTINE
ENCODER PITCH.
THE ENCODER PRODUCES
100 PULSES / INCH
OF MACHINE TRAVEL

Use the **▲** or **▼** keys to adjust the number of encoder pulses per inch of machine travel. Because microglue does all its calculations in inches this must be set to equal the number of encoder pulses per inch of machine travel. The microglue encoder produces 600 pulses per revolution and the friction wheel is 6 inches in circumference.

The value entered here depends on the actual encoder used and what part of the machine the encoder is mounted. If the standard GMS[®] encoder is used and it is applied to a belt or roller that is moving at the same speed as the product then the pulses per inch should be set to 100.

The next step is to set the encoder 2 pitch.

SET UP ROUTINE
ENCODER 2 PITCH.
THE ENCODER PRODUCES
100 PULSES / INCH
OF MACHINE TRAVEL
PRESS YES WHEN OK

Use the ▲ or ▼ keys to adjust the number of encoder pulses per inch of machine travel that the number 2 encoder will track. Because microglue does all its calculations in inches this must be set to equal the number of encoder pulses per inch of machine travel. The microglue encoder produces 600 pulses per revolution and the friction wheel is 6 inches in circumference.

The Setup Routine is now complete. **microglue[®] 228** will automatically enter the Auxiliary mode.

BASIC OPERATION

When **microglue® 228** is switched on, the display shows the software date, asks which language to use if more than one language had been selected in the set up routine, and then enters the auxiliary mode. The auxiliary mode screen displays the production rate in pieces/hour and machine speed in ft/min. The **MODE** key is used to switch between modes of operation. LEDs indicate which mode is displayed. The **MODE** key will allow you access each mode so that the information in each mode may be viewed or edited.

AUXILIARY MODE
PRODUCTION RATE IS
0 PIECES/HR
SPEED 1 0 F/M
SPEED 2 0 F/M

The production rate is displayed in increments of 1000 pieces/hr. The machine speed is displayed either in feet/minute or meters/minute. The **▲** or **▼** key will toggle through each screen available in the *AUXILIARY MODE*. Use the **↑** or **↓** keys to the left of the display to position the cursor and select the line to edit. Use the **▲** or **▼** keys to the right of the display to edit the data on the line selected.

Refer to the *AUXILIARY MODE* section of this manual for detailed instruction for each screen available in the *AUXILIARY MODE*.

Use the **MODE** key to toggle to *CHANNEL ONE MODE*.

CHANNEL 1
EVENT #1 OF 1
START AT 5.00IN
RUN FOR 10.00IN
STITCH ON .25IN
STITCHOFF 1.00IN

Use the **▲** or **▼** keys to adjust where the glue will start.
Use the **▲** or **▼** keys to adjust the length of glue pattern.
Use the **▲** or **▼** keys to adjust the length of the stitch on.
Use the **▲** or **▼** keys to adjust the length of the stitch off.

The **▲** or **▼** keys will toggle through each screen available in the *CHANNEL ONE MODE*. Use the **↑** or **↓** keys to the left of the display to position the cursor and select the line to edit. Use the **▲** or **▼** keys to the right of the display to edit the data on the line selected. Refer to the *CHANNEL OPERATION* section of the manual for detailed instructions for each screen available in the *CHANNEL ONE MODE*.

Use the **MODE** key to toggle to *CHANNEL TWO MODE*.

```

CHANNEL 2
EVENT #1 OF 1
START AT 5.00IN
RUN FOR 10.00IN
STITCH ON .25IN
STITCHOFF 1.00IN

```

Use the ▲ or ▼ keys to adjust where the glue will start.
 Use the ▲ or ▼ keys to adjust the length of glue pattern.
 Use the ▲ or ▼ keys to adjust the length of the stitch on.
 Use the ▲ or ▼ keys to adjust the length of the stitch off.

The ▲ or ▼ keys will toggle through each screen available in the *CHANNEL TWO MODE*. Use the ↑ or ↓ keys to the left of the display to position the cursor and select the line to edit. Use the ▲ or ▼ keys to the right of the display to edit the data on the line selected. Refer to the *CHANNEL OPERATION* section of the manual for detailed instructions for each screen available in the *CHANNEL TWO MODE*.

Use the MODE key to toggle to *COUNTER MODE*.

```

COUNTER
PRODUCT = 4,500,150
BATCHES = 145,001
BATCH COUNT = 50
BATCH SIZE = 100
BATCH KICK = 1,00s

```

Product count increments by one each time the opto is tripped. Batch count increments by one every time the batch reset value is exceeded. The ▲ or ▼ key will toggle through each screen available in the *COUNTER MODE*. Use the ↑ or ↓ keys to the left of the display to position the cursor and select the line to edit. Use the ▲ or ▼ keys to the right of the display to edit the data on the line selected. In this screen only the batch size and batch kick can be edited.

Refer to the *COUNTER MODE* section of this manual for detailed instruction for each screen available in the *COUNTER MODE*.

The MODE key will cycle back to *AUXILIARY MODE*.

AUXILIARY MODE OPERATION

The *AUXILIARY MODE* screen display the machine speed in feet/min or meters/min and production rate in pieces/hour, Product length setting set in inches or metric, Output cutoff speed set in ft/min or meters/min, Proportional control settings and the Open shutter / Purge option. Use the ▲ or ▼ key to scroll to each screen. The screens will rap around to get back to the top or take a short cut to get to the last screen.

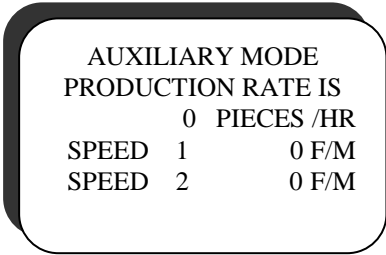

```
AUXILIARY MODE
PRODUCTION RATE IS
      0 PIECES /HR
SPEED  1      0 F/M
SPEED  2      0 F/M
```

The production rate is displayed in increments of 1000 pieces/hr. The machine speed is displayed either in, feet/minute or meters/minute. The ▲ or ▼ key will toggle through each screen available in the *AUXILIARY MODE*. Use the ↑ or ↓ keys to the left of the display to position the cursor and select the line to edit. Use the ▲ or ▼ keys to the right of the display to edit the data on the line selected. Since the values in this screen are related to measured data the ▲ or ▼ keys to the right of the display will not have any affect.

Use the ▼ key to scroll down to the next option.

microglue[®] will prompt the following:

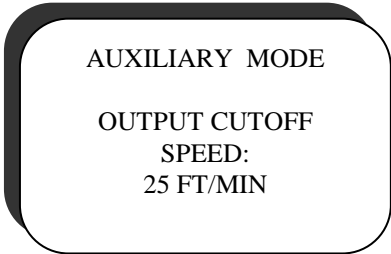

```
AUXILIARY MODE

OUTPUT CUTOFF
SPEED:
25 FT/MIN
```

Press the ▲ or ▼ keys to the right of the display to edit the Output cutoff speed.

The cutoff speed is the minimum speed the machine may run before **microglue**[®] disables the outputs, preventing puddles as the machine is coming to a stop. Enter a cutoff speed that is greater than your jog speed but less than your minimum run speed. Cutoff speed is one of two prerequisites that are used to determine if the glue valve shutters or pump control signals are set.

Use the ▼ key to scroll down to the next option.

microglue[®] will prompt the following:

AUXILIARY MODE
SHUTTERS OPEN
AND PUMP ENABLED
PURGING ALLOWED
WHEN AT THIS
SCREEN!

The green shutter and pump LED's will light and **microglue**[®] will open the shutter mechanisms and or turn on the hot melt pump. This allows purging for GMS valves with shutters or GMS hot glue guns. In addition to using the purge buttons on the glue applicator valves you can press and hold the **YES** key and the output keys **1**, **2**, **3** or **4** you wish to purge.

microglue[®] automatically opens the shutters and turn on the hot glue pump during operation when:

1. Machine speed is greater than the MINIMUM SPEED setting and . . .
2. At least one output has been enabled.

Press **▽** to continue after purging is completed. The shutters will close and the hot glue pump will stop. The Purge buttons will only operate while at this screen.

Use the **▽** key to scroll down to the next option. **microglue**[®] will prompt the following:

This screen allows you to configure the proportional control settings. The proportional control is the controller's ability to raise or lower the pressure at which adhesive is applied at varied speeds.

AUXILIARY MODE
PROPORTIONAL
CONTROL
MIN SPEED 300 F/M
MIN PRESS 30 PSI
MAX SPEED 1000 F/M
MAX PRESS 100 PSI

Use the **▲** or **▼** keys to adjust the min. speed for glue pressure.
Use the **▲** or **▼** keys to adjust the min. pressure of the glue.
Use the **▲** or **▼** keys to adjust the max. speed for glue pressure.
Use the **▲** or **▼** keys to adjust the max. pressure of the glue.

The **△** or **▽** key will toggle through each screen available in the *AUXILIARY MODE*. Use the **↑** or **↓** keys to the left of the display to position the cursor and select the line to edit. Use the **▲** or **▼** keys to the right of the display to edit the data on the line selected.

Example:

Set minimum speed for 0 ft/min

Set the minimum pressure for 10 psi

Set the maximum speed for 500 ft/min

Set the maximum pressure for 60 psi

The pressure will be at 10 psi while the machine is not running and rise at a rate of 10 psi for every 100 ft/min that the machine increases in speed. The pressure at 300 ft/min will be 40 psi

PRODUCT AND BATCH COUNTERS

microglue[®] 228 is equipped with a product and batch counter. To view the product and batch counter values press the **MODE** key until the counter LED is lit. The display will show the current product count and number of batches completed. The product and batch counter may be used independently of the gluing system.

COUNTER MODE
PRODUCT= 10,100,001
BATCHES = 1,010,000
BATCH COUNT = 9
BATCH SIZE = 10
BATCH KICK = 0.85S

Use the **▲** or **▼** keys located under the display to toggle through each screen available in the *COUNTER MODE*.

Use the **↓** or **↑** keys to the left of the display to position the cursor and select the line to edit.

Use the **▲** or **▼** keys to the right of the display to edit the data on the line selected.

The maximum product count is 99,999,999. The product counter will increment by one each time the optical sensor is tripped, provided that the product length has been exceeded each time the optical sensor is tripped.

The maximum number of batches is 99,999.

The product counter increments by one each time the optical sensor is tripped, up to 10,000,000.

The batch counter increments each time the amount of product fed through the equipment exceeds the designated reset value, up to 10,000.

It is very important to set the counter product length to the actual length of the product that is passing under the optical sensor. This will ensure that the counter correctly tracks the actual number of products as opposed to the number of times the optical sensor is tripped.

COUNTER MODE
PRODUCT LENGTH IS:
11.00 INCES

Use the **▲** or **▼** keys to adjust the product length value.

Adjust the production length to the actual length of the product as it passes under optical sensor number one. **All counting is done from the number one optical sensor input.**

To zero the product count or batch count, press the **▼** key while in the *COUNTER MODE*.

microglue[®] will prompt the following questions:



COUNTER MODE
ZERO THE PRODUCT
COUNTER?

Press the **YES** key to zero the product counter. Press **NO** to leave the value alone.

microglue[®] 228 will not ask if you want to zero the product counter if the product count is already zero.

Press  to go to the next option.

Zero batch counter?

Press the  key to zero the batch counter. Press the  key to leave the counter alone.

microglue[®] 228 will not ask if you want to zero the batch counter if the batch count is already zero.

.









If the kicker time is set to a value greater than zero, the kicker will operate for the programmed duration after each batch is completed. The kicker output may be wired into a device that mechanically stalls the feeder or speeds up the delivery system.







The product and batch counters are now ready for operation. Press  to return the first screen.

CHANNEL OPERATION

To program the **microglue**[®] 228 channels, press the **MODE** key until the desired Channel is displayed. Note: the LED for that channel adjacent to the **MODE** key will be illuminated. **microglue**[®] 228 will prompt the following display:

```
CHANNEL 1
EVENT #1 OF 1
START AT 5.00IN
RUN FOR 10.00IN
STITCH ON .25IN
STITCH OFF 1.00IN
```

Use the  or  keys to adjust where the glue will start.
Use the  or  keys to adjust the length of the glue pattern.
Use the  or  keys to adjust the length of the stitch on.
Use the  or  keys to adjust the length of the stitch off.

The  or  key will toggle through each screen available in the *CHANNEL MODE*. Use the  or  keys to the left of the display to position the cursor and select the line to edit. Use the  or  keys to the right of the display to edit the data on the line selected.









Hold the arrow keys down continuously to make large adjustments for the glue starting position, run length, stitch on or stitch off, for small changes a tapping technique works well.







Note that when the “Stitch off” value is zero, there is no stitching and the glue line will run continuously.





The **microglue**[®] 228 allows each channel to be programmed to produce four separate events, each event can be either a dot line or stitch pattern.

If a second, third or fourth event is not needed, simply set the run value for each event to zero.

```
CHANNEL 1
EVENT #2 OF 1
START AT 0.00IN
RUN FOR 0.00IN
STITCH ON 0.00IN
STITCH OFF 0.00IN
```

Use the  or  keys to adjust where the glue will start.
Use the  or  keys to adjust the length of glue.
Use the  or  keys to adjust the length of the stitch on.
Use the  or  keys to adjust the length of the stitch off.



The  or  key will toggle through each screen available in the *CHANNEL MODE*. Use the  or  keys to the left of the display to position the cursor and select the line to edit. Use the  or  keys to the right of the display to edit the data on the line selected.

Press the , ,  or  keys to enable each channel for operation.

Notice the yellow “Enable” LED illuminates when a channel is enabled.
The green “Active” LED will illuminate when the channel turns on the gluing device.
The red “off” LED is illuminated while the channel is not in use.

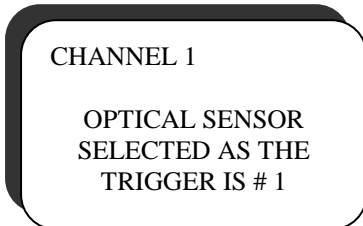
microglue[®] 228 allows each channel to be triggered by any of the four optical sensor inputs 1, 2, 3, or 4. To select the optical sensor input to trigger each channel, Press  key while the channel to be modified is displayed. **microglue**[®] will prompt the following display:





Use the  or  keys to the right of the display to select an optical sensor as a trigger.

You can select from either optical sensor number 1, 2 3 or 4.

The opto lead distance, encoder input and on and off compensation times must be entered correctly for the output to be programmed accurately and remain accurate throughout a range of speeds. To edit the compensation times and optical lead distance, press the  key while the channel to be modified is displayed.

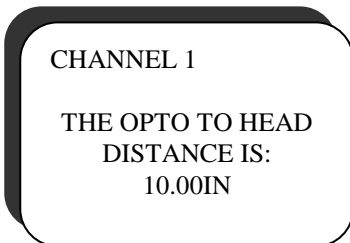

The opto to head distance is the distance the product travels from the opto to the nozzle of the glue valve. Do not assume that the **microglue**[®] 228 sees the product directly under the optical sensor as distance and angle may vary the trip point. Use the opto LED on the **microglue**[®] 228 display to mark the trip point and measure the products forward travel from there to the nozzle of the glue valve. Entering an accurate opto lead distance is critical for **microglue**[®] 228’s operating procedure. When done properly the “start at” and “run for” value will be exact in relation to the leading edge or reference position of the product, making programming simple. **microglue**[®] 228 will prompt the following display:

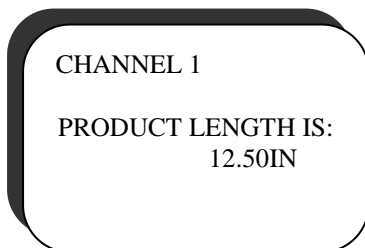

Use the  or  keys to the right of the display to edit the opto lead distance. The opto lead is the physical distance between the optical sensor and the glue gun nozzle. **If the optical sensor is positioned behind the glue gun nozzle that distance will need to be subtracted from the start value programmed to get accurate glue line/ dot placement.**

Press the  and **microglue**[®] 228 will prompt:



Press the  or  keys to the right of the display to edit the product length. The product length should be set to equal the length of the actual product traveling under the optical sensor selected for the channel being programmed



If **microglue**[®] 228 knows the length of the product, it will lock out and not permit false opto triggers on

product with windows or printing. If the product length is set too long **microglue® 228** may ignore the next product, leaving every other product unglued. Always remember to use the product length optical sensor lockout feature to protect against opto mis-triggers on products with printing or cutouts.

Use the  key to scroll down to the next option. **microglue® 228** will prompt the following:

Microglue 428 allows each channel to track the position of the product with either encoder input 1 or encoder input 2. To select the encoder input for each channel, Press  key while the channel to be modified is displayed. **microglue® 228** will prompt the following display:









CHANNEL 1
SELECT WHICH
ENCODER THIS CHANNEL
WILL
USE TO TRACK THE
PRODUCT, ENCODER # 1

Use the  or  keys to select the desired encoder input. You can select from either encoder input 1, or 2.

Press  to modify the on and off compensation times.

microglue® 228 will prompt the following display:

CHANNEL 1
ON COMP 3.50 MS
OFF COMP 2.50 MS
MIN ON 4.00 MS
MIN OFF 3.00 MS

Use the  or  keys to change the on compensation.
Use the  or  keys to change the off compensation.
Use the  or  keys to change the Minimum on duration.
Use the  or  keys to change the Minimum off duration.
Use the  key to change the device voltage.



The compensation times of a glue valve may vary over the life of the valve and with the use of different glues and pressures. Compensation allows the controller to maintain accurate position and length of the glue line through the range of operating speeds.



Compensation adjustments



If the start position moves toward the tail of the sheet as speed increases, the on compensation time needs to be increased. If the start position moves forward as speed increases, the on compensation time needs to be decreased. If the length of the glue line increases with speed, increase the off compensation time, if the glue line decreases in length as speed is increased lower the off compensation time.

Press  to modify the drive current settings.

| | |
|---------------|---------|
| CHANNEL 1 | |
| DRIVE CURRENT | 3.00A |
| HOLD CURRENT | 0.75A |
| DRIVE TIME | 3.00 MS |

Use the  or  keys to change the drive current.

Use the  or  keys to change the hold current.

Use the  or  keys to change the drive time.

To ensure these values are only changed intentionally the  key must be pressed and held while setting values.

GMS HP cold glue valves operate at 2.00 Amps drive and .30 Amps hold with a drive time of 2.50 MS. GMS HM100 hot glue valves operate at 3.00 Amps drive and .75 Amps hold with a drive time of 3.00 MS.

COLD GLUE SYSTEMS



The high volume cold glue delivery unit shown here is used where an uninterrupted flow of glue over long periods of time is required. Two tanks for glue are supplied with automatic tank switchover. Glue tanks can be refilled without affecting production. Level indicators are visible from a distance and an alarm activates if both tanks go low. A proportional control valve can be implemented for automatic pressure adjustment based upon machine speed.

GMS[®] also offers 2 and 5 gallon tank style delivery systems that consist of the same stainless steel canister style tanks.

In addition to the high volume and tank style delivery systems **GMS[®]** offers several different dual diaphragm pump style delivery systems. The pump systems are available with Proportional pressure control and or automatic water switch over systems

All tanks are assembled with quick release fittings, input pressure regulator, output shut off valve, filter, and flexible tubing. Properly maintained they will give years of trouble free service.

GMS[®] also supplies a variety of manifolds for glue delivery to multiple valves. Please contact **GMS[®]** for further details.

House air is required to supply pressure into the tank to push the glue through the delivery lines. Filters insure that heads do not become plugged with contaminants. The filter screen should be smaller than the smallest orifice in the head nozzles. It should also be larger than the filter the manufacturer used to prepare the glue (refer to specification sheets). Adjust the air regulator to adjust the glue pressure. If there is a problem with glue delivery, refer to the basic troubleshooting section later in this manual. Please note—

- Pour water or adhesives directly into the tank.
- Flush adhesives out with warm water, or warm water and ammonia.
- Only use adhesives that are listed in the GLUE section of this manual (or equivalents).
- **Never mix glues**, they may react and cause problems.
- Keep the filter clean.
- Stir glues thoroughly before using.
- Be certain that the air supply to the delivery system is able to provide at least 80 psi @ 1cfm.
- The air supply must be filtered for both water and oil.
- Glues used below their rated temperature may need to be thinned. **A twenty-degree Fahrenheit reduction in temperature doubles the viscosity of most glues.**
- Tank heaters are available and are recommended for areas where temperatures are consistently below sixty degrees Fahrenheit. Never allow glue to freeze.
- Keep pressure in the tanks when not in use to minimize skinning of the exposed glue surface.

METHODS OF PIPING THE COLD GLUE TO THE HEADS

Straight connection: Remove glue from tank and replacing it with water (solvent) for cleaning

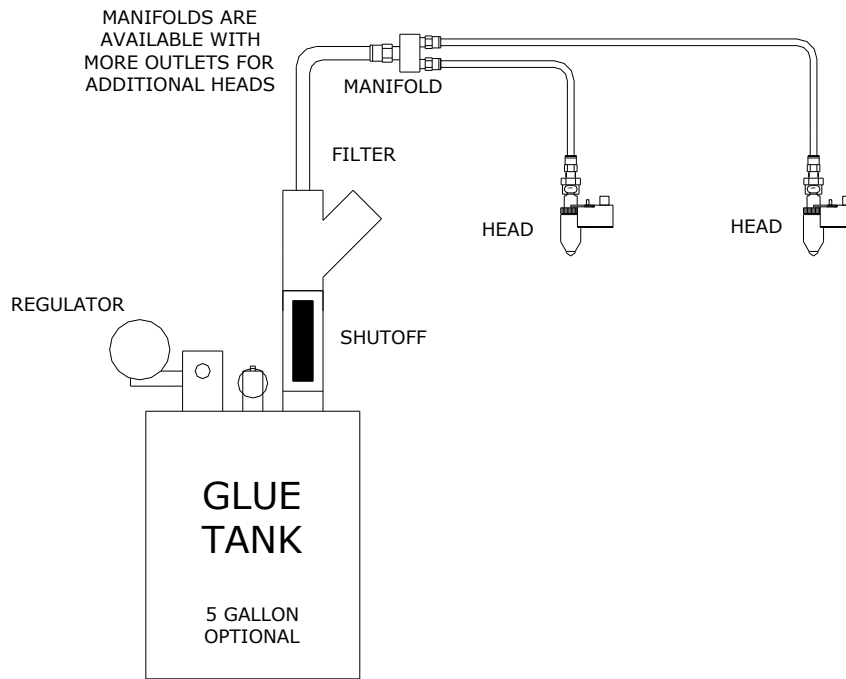

Valves to allow direct flushing of each head. To clean the lines (should be done regularly and ANY time that the glue type is changed) remove the delivery line quick disconnect assembly at the glue tank and move it to the water (solvent) tank.

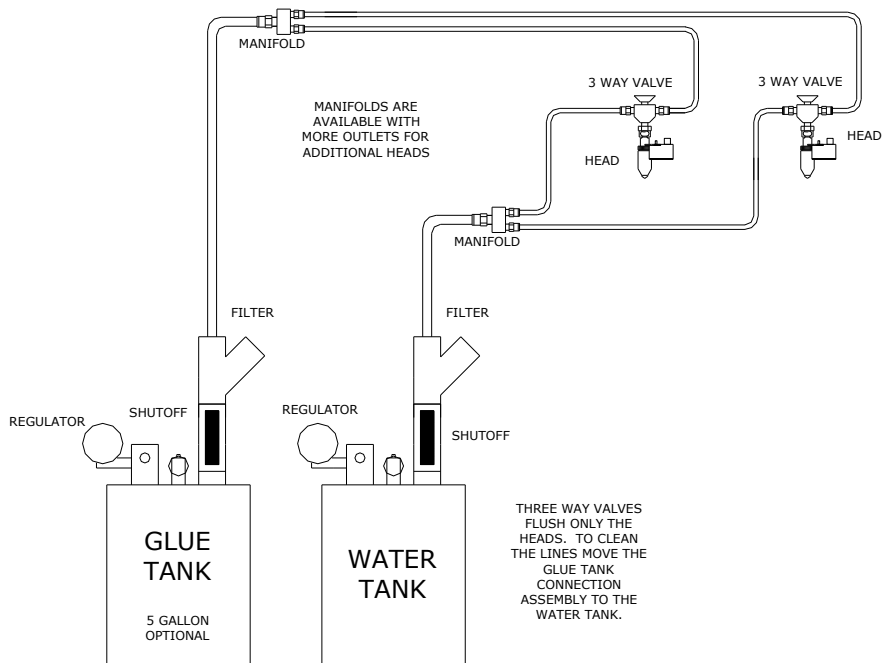

COLD GLUE APPLICATOR VALVES

GMS® offers different glue valves for different applications. The GMS® LP valves work best with low viscosity or low solid content glue. They will fit in tight locations such as between fold plates. Optional equipment includes a shutter mechanism. This requires that a 1/8 inch pneumatic control line be attached from the small barbed fitting on the stainless steel block assembly to a control valve wired to the controller.

The **microglue**® LP valve uses two forms of purging (an electrical switch and a manual purge button), both located on the front of the applicator valve. The electrical switch purges the valve mechanism at a frequency controlled by the **microglue**® controller. The manual purge switch may be used to purge the valve even if the cable is removed. Use only the manual switch when priming the lines.



OPERATING INSTRUCTIONS

1. Connect the cable to the valve's electrical connector making sure that the key positions line up.
2. Insert 1/4" tubing into press-lok™ fluid fitting. Be sure the end of tube is cleanly and evenly cut.
3. Adjust the tank pressure to the glue valve to 20-35psi or 2-4 bars.
4. Press the manual purge button to introduce glue into the valve.
5. Press the electric purge switch on glue valve to verify operation. The valve should turn on and off at the frequency programmed (see SETUP).



Caution—Use only adhesives that are identified to work properly with the system. Other adhesives may not flow, could damage the glue valve or delivery system, or may compromise the integrity of the paper bond. Clean the glue head after every use and seal the orifice with petroleum jelly. Remove nozzle with 1/4" nut driver and flush with water to clear obstructions. Glue valves with shutters require the removal of the shutter mechanism to access the nozzle. Never operate glue valve without fluid.



SPECIFICATIONS

| | |
|-----------------------|---------------|
| Operating voltage | 12 VDC |
| Current | 380 ma |
| Power dissipation | 4.56 W |
| On compensation time | 2.50 – 3.75ms |
| Off compensation time | 2.00 – 2.5ms |
| Maximum stitch speed | 150 Hz |

Specifications subject to change without notice

Shown: glue valve with shutter mechanism.

The higher profile **GMS**[®] HP applicator offers high performance with the ability to run higher viscosity glues. This valve uses electrical purge only. The switch is located on the top of the applicator valve. The electrical switch purges the valve mechanism at a frequency controlled by the **microglue**[®] controller. The HP also has stroke adjustment for volume regulation.

OPERATING INSTRUCTIONS

1. Connect the cable to the valve's electrical connector making sure that the key positions line up.
2. Connect the ¼" tubing to the quick release coupling barb fitting.
3. Adjust the tank pressure to the glue valve to 30-90 lb or 2-6 bars.
4. Adjust the stroke by rotating the valve plug clockwise until it stops then backing off 1/4 turn. This is the recommended starting position.
5. Thoroughly flush the system with water or appropriate solvent for extended down times.
6. For full system flushing it is recommended that the nozzle on the tip of the gun be loosened to allow continuous free flow of the glue.
7. Be sure the valve is clean and free of glue when not pressurized or when removed from the machine.
8. Apply petroleum jelly to tip of nozzle for short down periods to prevent clogging.

Caution— Use only adhesives that are identified to work properly with the system. Other adhesives may not flow, could damage the glue valve or delivery system, or may compromise the integrity of the paper bond. Clean the glue head after every use and seal the orifice with petroleum jelly. Remove nozzle with ¼" nut driver and flush with water to clear obstructions. Never operate glue valve without fluid.



SPECIFICATIONS

| | |
|-----------------------|------------------------------|
| Operating voltage | 12 VDC |
| Current | 660ma |
| Power dissipation | 7.92 W |
| On compensation time | 2.50 – 4.0ms |
| Off compensation time | 1.75 – 2.5ms |
| Maximum frequency | 500 Hz |
| Maximum duty cycle | 100% |
| Viscosity range | 1000 cps at 50% solids |
| Maximum pressure | 125 psi, 8.77Kg/cm, 4.13 bar |

Shown: HP Glue Valve

The glue valves supplied with your **microglue**[®] system are precision devices and must be treated with care. Failure to clean the valves may result in damage requiring replacement of parts.

All of the above valves mount on brackets designed to fit into a cutout toward the rear of the valve. There are several different types of mounting brackets and depending on the application, different brackets may be used. The mounting bracket can then be attached to the clamping bracket on the cross bar. The applicator valve is connected with the supplied cable. Carefully align the keyed connector housings and insert the connector onto the applicator valve. The cable can be removed by pulling back on the collar, then sliding the connector off. Plug the other end of the cable into any output connector on the **microglue**[®] controller.

HP VALVE REBUILD INSTRUCTIONS

1. REMOVE LOCK PLATE (3) FROM VALVE BODY, 2 SCREWS (11)
2. REMOVE (UNSCREW) HP GLUE VALVE POLE (1)
3. REMOVE SPRING (7), COREPIN (5), NOZZLE (4) AND O-RINGS (8,9) FROM POLE (1)
4. CLEAN VALVE POLE (1) AND VALVE BODY THOROUGHLY. REMOVE ANY GLUE RESIDUE.
5. PUT NEW NOZZLE (4) ON VALVE BODY.
6. PUT NEW O-RINGS (8,9) ON POLE (1) AND LUBRICATE O-RINGS (SILICONE SPRAY OR O-RING LUBE)
7. PUT NEW PIN (5) AND SPRING (7) ON POLE (1) AND CAREFULLY INSERT INTO VALVE BODY.
8. RESET "STROKE" BY TURNING THE POLE (4) CLOCKWISE BY HAND UNTIL IT STOPS (WITHOUT TORQUING THE POLE) THEN BACK OUT A ¼ TURN.
9. PLUG CABLE TO GLUE VALVE AND TEST PURGE.

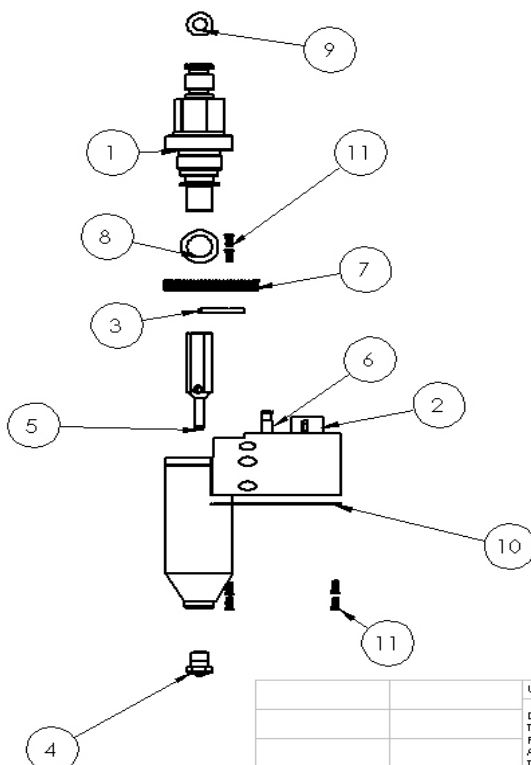

| ITEM NO. | PART NUMBER | DESCRIPTION | QTY. |
|----------|-------------|------------------|------|
| 1 | HP-23004 | POLE | 1 |
| 2 | GV-23107 | HIROSE CONNECTOR | 1 |
| 3 | HP-23013 | LOCK PLATE | 1 |
| 4 | HV-230XX-B | NOZZLE | 1 |
| 5 | HP-23001 | CORE PIN | 1 |
| 6 | HP-23020 | PURGE SWITCH | 1 |
| 7 | HP-23026 | SPRING | 1 |
| 8 | HP-23027 | POLE O-RING | 1 |
| 9 | HP-23028 | INSERT O-RING | 1 |
| 10 | HP-23015 | COVER PLATE | 1 |
| 11 | GV-23512 | 0-80 X 1/8 SCREW | 6 |

Stroke adjustment is accomplished by rotating the valve plug(1). As a starting position, rotate the plug clockwise until it stops then back it off 1/4 turn. Be careful not to force the plug past finger tight when rotating clockwise.

The valve can be disassembled for cleaning by removing the two Philips screws(11) holding down the lock plate(3) and unscrewing the valve plug(1) all the way. The lock plate should always be re-installed before valve is returned to use. Removing the nozzle(4) is recommended for cleaning and for system flushing. Use a 1/4" wrench for nozzle removal.

Note: During reassembly, install nozzle first. Installing nozzle with the valve plug adjusted too far down can cause damage to the nozzle and the solenoid core(5).

PROPRIETARY AND CONFIDENTIAL
THE INFORMATION CONTAINED IN THIS DRAWING IS THE SOLE PROPERTY OF <INSERT COMPANY NAME HERE>. ANY REPRODUCTION IN PART OR AS A WHOLE WITHOUT THE WRITTEN PERMISSION OF <INSERT COMPANY NAME HERE> IS PROHIBITED.

| | | | | |
|---|----------------------|-----------|------|---------------------------------|
| UNLESS OTHERWISE SPECIFIED: | | NAME | DATE | GMS |
| DIMENSIONS ARE IN INCHES TOLERANCES: FRACTIONAL ± ANGULAR: MACH ± BEND ± TWO PLACE DECIMAL ± THREE PLACE DECIMAL ± | | DRAWN | | |
| INTERPRET GEOMETRIC TOLERANCING PER: | | Q.A. | | SIZE DWG. NO. REV |
| MATERIAL | | COMMENTS: | | A HP EXPLD |
| FINISH | | | | SCALE: 1:2 WEIGHT: SHEET 1 OF 1 |
| APPLICATION | DO NOT SCALE DRAWING | | | |

5

4

3

2

1

HP Cold Glue Nozzles

| PART NUMBER | SIZE |
|--------------------|-------------|
| HV-23061-B | .0055 |
| HV-23063-B | .008 |
| HV-23067-B | .012 |
| HV-23077-B | .018 |
| HV-23085-B | .020 |
| HV-23087-B | .024 |

Hot Glue Systems

HM25 MELT UNIT

Innovative new technology makes the GMS HM25-2, 4, 6 & 8 the best performing melt unit available.

Unparalleled features and benefits make the HM25 a perfect choice for commercial printing, mailing and bindery applications.

HM25 Melt Unit

25 pound advanced Teflon coated tank

2, 4, 6 and 8 hose/gun configurations

Digitally controlled output pressure

24 Hour Timer for auto start-up

HM25 series melt units are designed to provide ultra-high performance, precise pressure and temperature control and outstanding features for fugitive, permanent, re-moistenable or pressure sensitive hot melt adhesives.

Our proprietary closed loop torque sensing motor drive system allows the unit to be digitally set to deliver an exact pressure. Feedback from an integrated pressure transducer is constantly monitored eliminating any variation in output pressure regardless of the load. The pressure can be set either manually on the melt unit or via the external GMS pattern controller. This pressure setting can be fixed or proportional to machine speed. There are many advantages of our new innovative pumping technology, it offers all of the advantages of both piston and gear pumps without any of the drawbacks. The fact that the pump motor only rotates when needed pumping only enough glue to offset consumption. This concept



100 pound/hour melt and pump rate

Optional tank level detection with low level alarm

Energy-Miser, power conservation technology, a green solution!

eliminates the primary disadvantage of a gear pump because there is no recirculation of the glue which causes molecular breakdown. Alternatively, since the pump output is digitally set and pressure maintained at an exact setting there is no momentary lapse in output pressure like with a piston pump designs

The new high performance Teflon coating used on the cast aluminum tank is rated for applications over 1000 degrees F and extremely resistant to abrasion. The 25 pound capacity tank holds enough glue to satisfy most graphic arts related applications. The tank casting design has been engineered for optimum heat transfer enabling the unit to melt a greater amount of adhesive with less energy.

The GMS HM25 hot glue unit is an integral part of a high tech GMS adhesive application system.

HM25 2, 4, 6 & 8 Head/Hose

Melt Unit

Specifications:

| | |
|---------------------------------|--------------------------------|
| Hydraulic Pressure ¹ | 500 psi |
| Tank Capacity | 25 Pound |
| Pump Rate ¹ | 100 Pound/Hour |
| Melt Rate | 100 Pound /Hour |
| Working Viscosity | 20,000 cps |
| Sensing Technology | Thermistor, 10,000 ohm |
| Electrical Requirements | 208-240VAC Single Phase 20 amp |
| Wattage | 7,200 Watts |
| Dimensions | 16.5" W x 22" L x 16" H |
| Weight | 96 LBS |

Note, The GMS microglue[®] hot glue system does not require pressurized air.

¹ Performance will be affected by higher viscosity adhesives.
Recommended viscosity is 500 - 3000cps for optimum performance.

Features:

Each temperature zone which includes the tank, each hose and each applicator are independently set.

The variable torque gear pump drive system allows you to set the desired output pressure to an exact value and can be increased or decreased by using the up and down arrow keys.

The system has a built in 24 hour timer for automatic start-up and a standby mode so that the system can be partially cooled down between jobs

HM25 units are field upgradable from 2 to 8 hoses/guns. Upgrade kits contain an output PC board assembly and a connection wire harness assembly. The system will automatically recognize the addition of the PC board and will reconfigure itself for the correct number of outputs.

The melt unit is securely mounted to a rolling stand assembly with a built in extension cord, lockable casters, an auxiliary mounting bar for storing unused applicators and two shelves for tools or adhesives.



GMS offers a 24 VDC controlled hot melt applicator valve that can be run directly from the controller—

HM HOT GLUE GUN

- Complete electric operation - no air needed for extrusion applications.
- Precise needle and seat action produces clean cutoff and prevents dripping.
- Free floating valve design with no internal seals to wear out for long service life.
- Built in thermistor sensor for accurate temperature control of applicator.

HM-23500
HM-23055

HM Electric Head 24 VDC
HM Electric Head Nozzle



HM 100 REBUILD INSTRUCTIONS

1. HEAT UP VALVE AND MAKE SURE PUMP IS OFF.
2. LOOSEN SET SCREW AND REMOVE POLE CAP (13)
3. BACK POLE (4) OUT TWO REVOLUTIONS COUNTER CLOCKWISE.
4. VALVE IS EASIER TO REBUILD IF YOU CAN SECURE IT POINTING UPWARD.
5. UNSCREW SEAT NUT (8) CAREFULLY, NOZZLE (2) IS UNDER PRESSURE BY SPRING (7), THEN UNSCREW NOZZLE BASE (3)
6. PULL CORE PIN (1) AND SPRING (7) OUT.
7. CAREFULLY INSERT NEW PIN (1) AND SPRING (7) MAKING SURE SPRING (7) SITS INSIDE POLE (4) PROPERLY.
8. REMOVE USED BASE O-RING (6) FROM NOZZLE BASE AND REPLACE WITH NEW O-RING (6), THEN REATTACH NOZZLE BASE (3) TO VALVE BODY.
9. POINT GLUE VALVE BACK DOWNWARD AND PUMP SOME GLUE THRU THE VALVE TO FLUSH OUT ANY DEBRIS.
10. PLACE NOZZLE (2) INSIDE SEAT NUT (8) AND REATTACH TO NOZZLE BASE (3) MAKING SURE THE TIP OF THE CORE PIN (1) IS CENTERED TO THE BACK OF THE NOZZLE (2).
11. RESET "STROKE" BY TURNING THE POLE (4) CLOCKWISE UNTIL IT STOPS THEN BACK OUT A ¼ TURN. PLACE POLE CAP (13) BACK IN POSITION AND SECURE WITH SET SCREW.

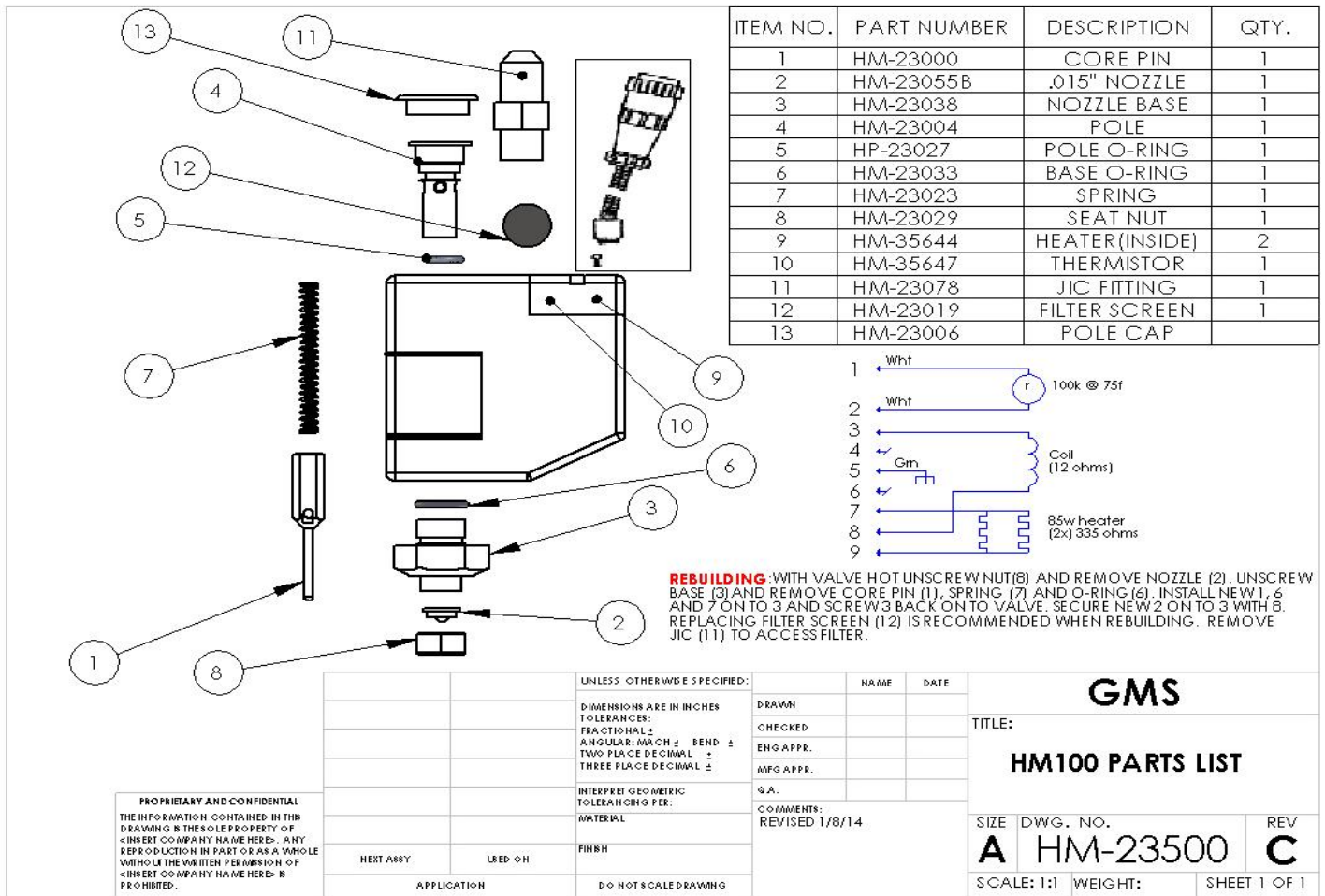

HM-100 Nozzles

| PART NUMBER | SIZE | DESCRIPTION |
|-------------|------|---------------------------------|
| HM-23065 | .010 | HM low profile nozzle |
| HM-22053 | .012 | HM low profile nozzle |
| HM-23055 | .015 | HM low profile nozzle |
| HM-23057 | .018 | HM low profile nozzle |
| HM-23059 | .020 | HM low profile nozzle |
| HM-23060 | .025 | HM low profile nozzle |
| HM-23062 | .012 | HM Right angle nozzle |
| HM-23031 | .012 | HM Right angle 45* nozzle block |
| HM-23030 | .015 | HM Valve, Replaceable tip |
| HM-23090 | .012 | HM 100 split nozzle, Three jet |

HM Handheld Applicators.

Hand held applicator valves for manual jobs are also available.

- Ergonomic lightweight design (1.7 lbs.).
- Supply fitting comes into top of handgun for ease of use with overhead hose configurations.
- Separate trigger switch for gear pump motor and air activation for swirl/spray provides precise material dispensing and increases pump life.
- Built in thermistor sensor for accurate temperature control of applicator.
- Hose connection swivels 360° for versatility and to avoid twisting.
- Safety trigger lock.
- Use with optional Hose Cradle/Balancer and adapters below for a complete solution.



INSTALLATION

microglue[®] is a distance based programmable control system that requires the use of an optical sensor and encoder to detect the leading edge and velocity of the product. The peripheral components must be installed correctly and in the appropriate positions for **microglue**[®] to operate properly.

CROSS BAR BRACKET

The cross bar is used as a support for mounting the other components. Locate a position where the cross bar can be mounted across the machine, usually near where the glue valves need to be installed. The installation may vary depending on the application. On some installations the cross bar will support all of the components, optical sensor, encoder, glue valves and the controller, while others may require components to be mounted elsewhere.

Position the vertical brackets with two slots on the side frame of the machine with the cutout for the horizontal pieces facing inward. Fasten the horizontal brackets within the cutout of the vertical pieces and secure using the 1/4-20x3/4" thumbscrew. Slide the 3/4

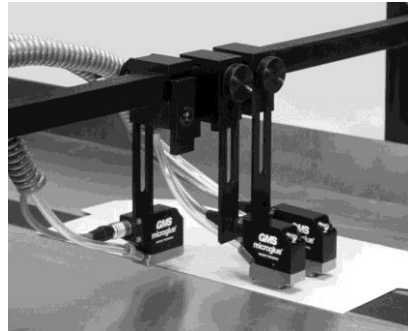

inch cross bar through the horizontal pieces and secure by tightening the Phillips screws.

ENCODER

The encoder is used to measure the speed that the product is traveling. The friction wheel must be resting on a surface that is traveling at the same speed as the product. The encoder can usually be mounted on one of the drive rollers or a belt.

The encoder has a built-in bidirectional spring mechanism and should be fastened so the spring tension provides adequate friction to keep the velocity wheel from slipping. Secure the encoder to the slotted bracket with a 1/4 -20 nut and lock washer.

The encoder can be adjusted horizontally by loosening the screws which hold the 1/2" bar, or vertically by sliding the encoder up on its slotted bracket.

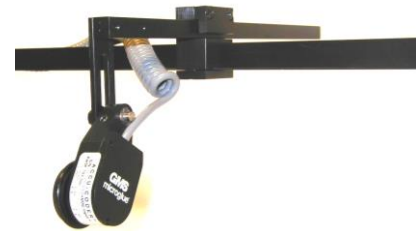

Built into the encoder is a 12' cable. Plug the cable into the operator console into the appropriate receptacle on the **microglue**[®] controller.

Warning- Make sure no hazards are created or safety features compromised by installing the encoder.

OPTICAL SENSOR

GMS offers two basic optical sensors. The current sensor is made by Carlo Gavazzi, the instruction for setting the sensitivity is described below.

Photoelectrics Diffuse-reflective Type PD30CND10....RT



- Miniature sensor range
- Range: 1 m
- Sensitivity adjustment by Teach-In programming
- Modulated, red light 660 nm
- Supply voltage: 10 to 30 VDC
- Output: 100 mA, NPN or PNP preset
- Make or break switching function programmable
- LED indication for output, stability and power ON
- Protection: reverse polarity, short circuit and transients
- Cable and plug versions
- Excellent EMC performance
- Remote teach features

Product Description

The PD30CND10 sensor family comes in a compact 10 x 30 x 20 mm reinforced PMMA/ABS housing. The sensors are useful in applications where high-accuracy detection as well as small size is required. Compact housing and high power LED for excellent performance-size ratio.

The Teach-In function for adjustment of the sensitivity makes the sensors highly flexible. The output type is preset (NPN or PNP), and the output switching function is NO or NC output. A remote teach feature allow the sensor to be set up from e.g. a PLC.

Ordering Key

PD30CND10PPM5RT

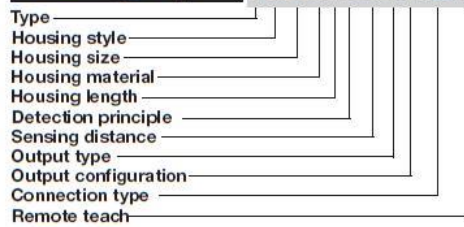

Type Selection

| Housing W x H x D | Range S _n | Connection | Ordering no. NPN Make or break switching | Ordering no. PNP Make or break switching |
|----------------------|-------------------------|------------|--|--|
| 10 x 30 x 20 mm | 1 m | Cable | PD 30 CND 10 NPRT | PD 30 CND 10 PPRT |
| 10 x 30 x 20 mm | 1 m | Plug | PD 30 CND 10 NPM5RT | PD 30 CND 10 PPM5RT |

Specifications

| | | | |
|--|---|---------------------------------------|--|
| Rated operating distance (S_n) | Up to 1 m, with reflector Ø 80 mm (ER4) 4 m on ER4060 reflector | Light type | Red, modulated |
| Blind zone | 20 mm | Sensing angle | ± 2° |
| Sensitivity | Adjustable by Teach-In | Ambient light | 10,000 lux |
| Temperature drift | ≤ 0.1%/°C | Light spot | 110 mm @ 1.5 m |
| Hysteresis (H) (differential travel) | ≤ 10% | Operating frequency | 1000 Hz |
| Rated operational volt. (U_B) | 10 to 30 VDC (ripple included) | Response time | |
| Ripple (U_{rip}) | ≤ 10% | OFF-ON (t _{ON}) | ≤ 0.5 ms |
| Output current | | ON-OFF (t _{OFF}) | ≤ 0.5 ms |
| Continuous (I _B) | ≤ 100 mA | Power ON delay (t_d) | ≤ 300 ms |
| Short-time (I) | ≤ 100 mA (max. load capacity 100 nF) | Output function | |
| No load supply current (I₀) | ≤ 30 mA @ 24 VDC | NPN and PNP | Preset |
| Minimum operational current (I_m) | 0.5 mA | NO/NC switching function | Set up by button |
| OFF-state current (I₁) | ≤ 100 µA | Remote teach function | |
| Voltage drop (U_d) | ≤ 2.4 VDC @ 100 mA | Teach on | 0 to 2.5 VDC (NPN) 5 to 30 VDC (PNP) |
| Protection | Short-circuit, reverse polarity and transients | Tamper proof | When activated more than 20 sec. the sensor goes into a Tamper proof mode. |
| Light source | GaAIAs, LED, 660 nm | Indication | |
| | | Output ON | LED, yellow |
| | | Signal stability ON and power ON | LED, green |
| | | Environment | |
| | | Installation category | II (IEC 60664/60664A; 60947-1) |

Specifications are subject to change without notice (02.07.2007)



Specifications (cont.)

| | | | |
|----------------------------|--|------------------|--|
| Pollution degree | 3 (IEC 60664/60664A; 60947-1) | Housing material | ABS |
| Degree of protection | IP 67 (IEC 60529; 60947-1) | Body | PMMA, red |
| Ambient temperature | | Front material | |
| Operating | -25° to +55°C (-13° to +131°F) | Connection | |
| Storage | -40° to +70°C (-40° to +158°F) | Cable | PVC, black, 2 m 4 x 0.14 mm ² , Ø = 3.6 mm |
| Vibration | 10 to 55 Hz, 0.5 mm/7.5 g (IEC 60068-2-6) | Plug | M8, 4-pin (CON. 54-series) |
| Shock | 30 g / 11ms, 3 pos, 3 neg per axis (IEC 60068-2-6, 60068-2-32) | Weight | With cable: 40 g With plug: 10 g |
| Rated insulation voltage | 500 VAC (rms) | CE-marking | Yes |
| | | Approval | cULus (UL 508) |

Operation Diagram

tv = Power ON delay

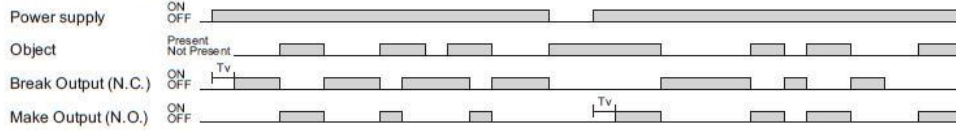

Wiring Diagrams

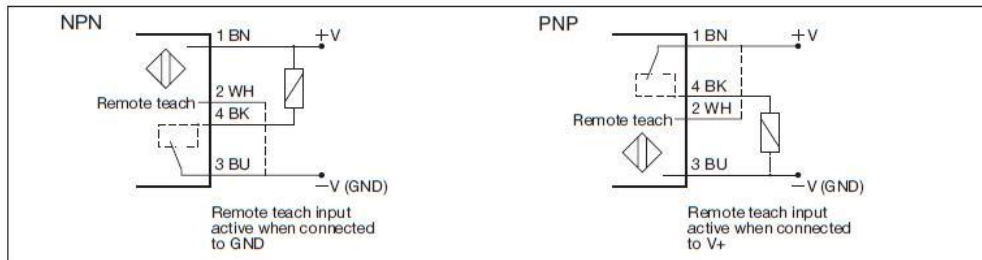

Detection Diagram

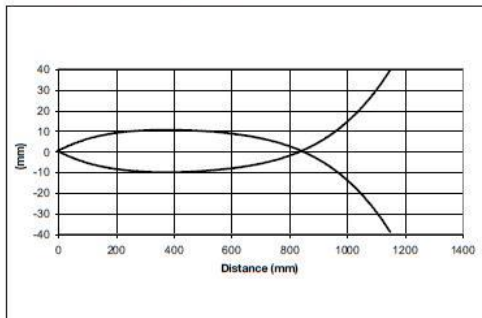

Excess Gain

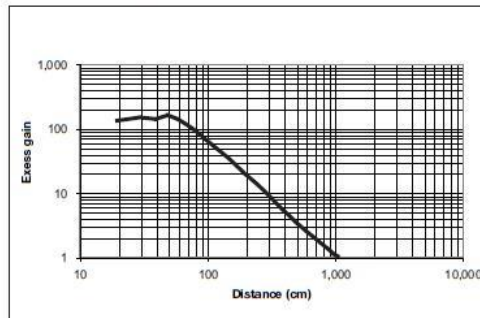



Signal Stability Indication

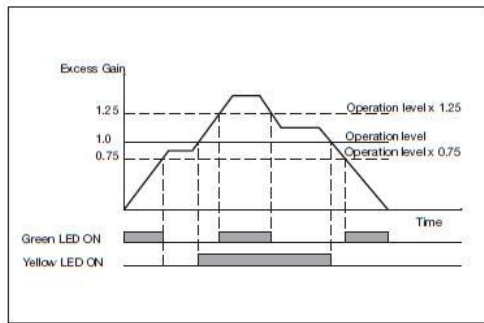

Accessories

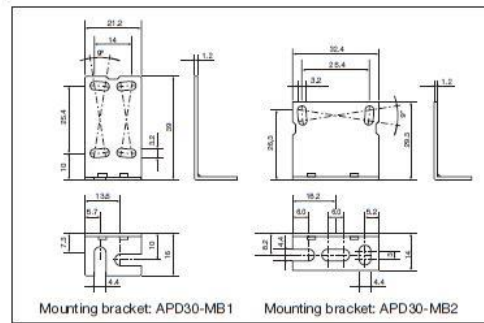

Dimensions

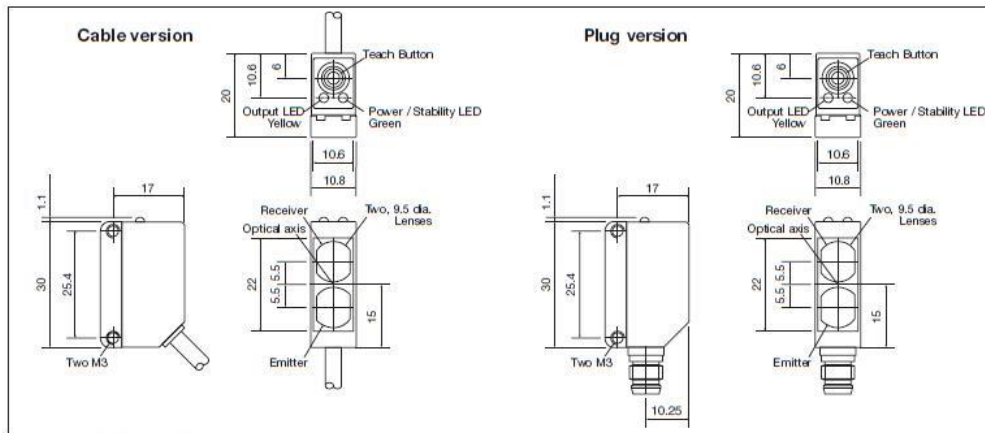

Installation Hints

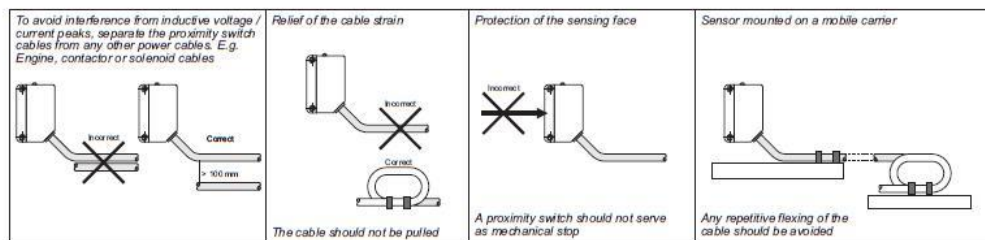

Delivery Contents

- Photoelectric switch: PD 30 CND 10 ...
- Installation instruction
- Mounting bracket APD30-MB1
- Packaging: Cardboard box

Accessories

- Mounting bracket APD30-MB2 to be purchased separately

Teach functions

Normal operation, optimized switching point.

1. Line up the sensor at the background. Yellow LED is OFF and Green LED is ON.
2. Press the button for 3 seconds until both LEDs flashes simultaneously.
(The first switch point is stored)
3. Place the object in the detection zone.
4. Press the button once and the sensor is ready to operate (Green LED ON, Yellow LED ON)
(The second switch point is stored)

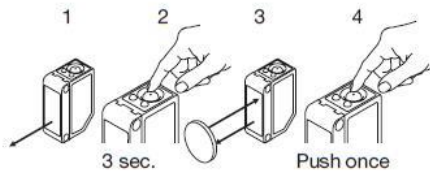

For dynamic set-up (running process)

1. Line up the sensor at the object. Green LED is ON, status on the yellow LED is not important.
2. Press the button for 3 seconds until both LEDs flashes simultaneously.
3. Press the button a second time for at least one second, both LEDs flashes fast simultaneously and keep the button pressed for at least one process cycle, release the button and the sensor is ready to operate (The second switch point is stored)

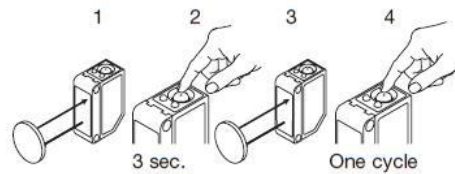

For maximum sensing distance (default setting)

1. Line up the sensor at the background. Yellow LED is OFF and Green LED is ON.
2. Press the button for 3 seconds until both LEDs flashes simultaneously.
(The first switch point is stored)
3. Press the button a second time and the sensor is ready to operate (Green LED ON, Yellow LED ON)
(The second switch point is stored)

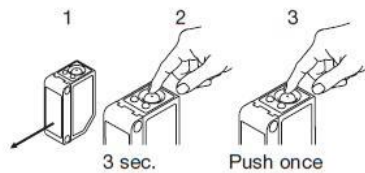

For make or break set-up (N.O. or N.C.)

1. Press the button for 10 seconds, until the green LEDs flashes.
2. While the green LED flashes, the output is inverted each time the button is pressed. Yellow LED indicates N.O. function selected.
If the button is not pressed within the next 10 seconds, the current output is stored.

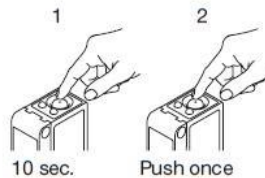

For minimum detection overhead.

1. Line up the sensor at the object. Yellow LED is OFF and Green LED is ON.
2. Press the button for 3 seconds until both LEDs flashes simultaneously.
(The first switch point is stored)
3. Press the button a second time and the sensor is ready to operate (Green LED ON, Yellow LED ON)
(The second switch point is stored)

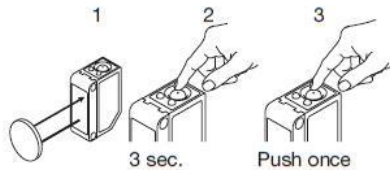

The earlier systems were sold with a sensor made by P&F, the instructions for its adjustment are described below.

The optical sensor needs to be mounted so that the product travels under it *prior* to the glue applicator valves. Mount the sensor as close to the product as possible for maximum sensitivity. It may be necessary to angle the sensor across the sheet or provide a dark background to reduce the amount of reflection from the surface it sees when the product is not there.

To adjust the sensitivity of the sensor, turn the sensitivity adjustment pot counter-clockwise to the minimum. Feed the product under the sensor and turn the sensitivity adjustment pot clockwise to the point where the green “**opto**” led on the console turns on. Remove the product from under the sensor. If the “**opto**” LED on the console remains lit it will be necessary to darken the background area or move the sensor to a location where the background does not create a reflective surface. The sensor can be angled reducing the effects of the background reflection.

Sensitivity Adjustment Pot

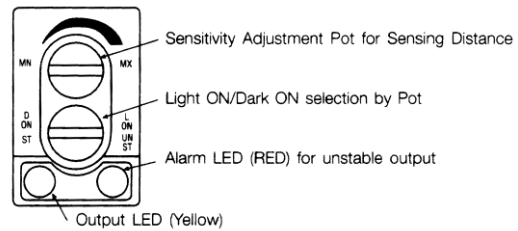

When working with light product, provide a dark background and set the sensor to “LIGHT ON” by turning the Light ON/Dark ON selection pot clockwise. When working with a dark product, provide a light background and set the sensor to “DARK ON” by turning the Light ON Dark ON selection pot counter-clockwise.

The optical sensor is mounted using the two 3mm screws. The bracket allows the sensor’s angle and height to be adjusted. The opto mounting bracket is then positioned onto the Snap-On bracket and fastened with a thumbscrew. Plug the 24” coiled cable into the connector on the sensor and into the appropriate receptacle on the **microglue**[®] controller.

CONTROL CONSOLE

Mount the operator console in a location where it can be seen and reached easily. Mount to the cross bar using the supplied brackets.

DELIVERY SYSTEM

Without an adequate supply of glue and the ability to move glue freely to the applicator valve, the system will not operate properly. Connect the pressure tank to the glue distribution manifold using large diameter tubing. Keep tubing length to a minimum. Avoid tight turns that may cause the tubing to kink.

APPLICATOR VALVES

Mount the applicator valve on its bracket using the screws provided so that it hangs above the location that the glue will need to be applied. Connect the glue supply and power lines according to the type of valve being used.

LP glue applicator valves equipped with a shutter mechanism require a 1/8 inch pneumatic control line attached to the small barbed fitting on the stainless steel block assembly. The control system for the shutter is part of the delivery system.

HEAVY DUTY BRACKET SET

GMS offers a heavy duty bracket set with micro head height adjustment and hold down bars. These mount to the same 3/4" cross bar that the standard mounting brackets use.

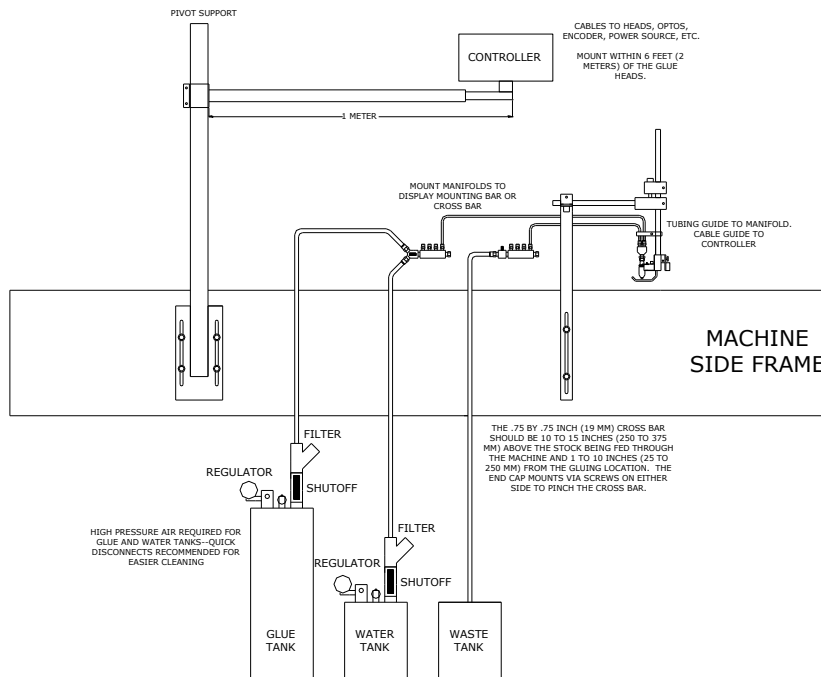
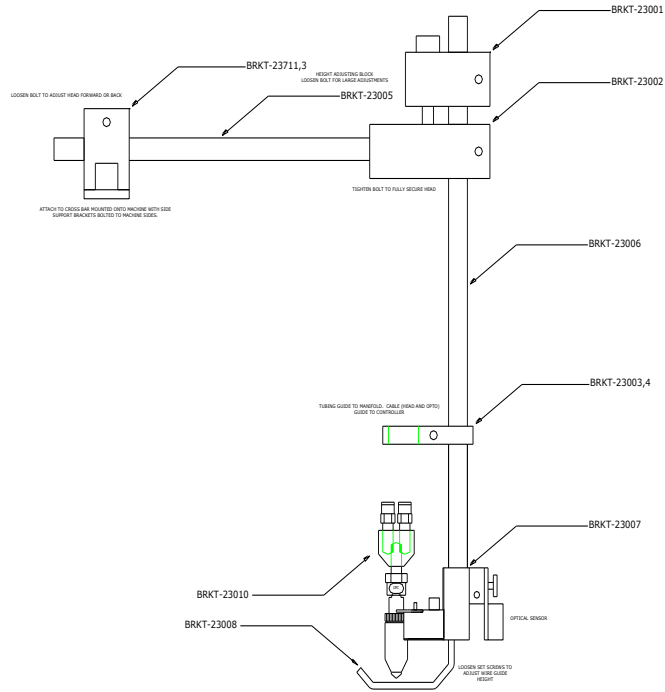

GLUE

To ensure best results, only the adhesives listed below or their equivalents should be used in the GMS valves. Use of adhesives that have exceeded their rated shelf life or have been improperly stored will provide unsatisfactory results. Store adhesives at room temperature. If adhesives are used while below 70 degrees Fahrenheit (21 C), it may be necessary to either dilute the adhesive or raise the temperature. **A 20 degree F (11 C) drop in temperature may double the viscosity.**

This list is regularly updated, so please call for additional manufacturers and products.

| Manufacturer | Part # | HP | HM-100 |
|-------------------|------------|-----|--------|
| Adhesive Products | 2173 | Yes | No |
| Adhesive products | 2179 | Yes | No |
| Capital Adhesives | R90506 | Yes | No |
| Capital Adhesives | R 40603 | Yes | No |
| Capital Adhesives | R 41102 | Yes | No |
| Capital Adhesives | R 42903 | Yes | No |
| Capital Adhesives | R 47703 | Yes | No |
| Capital Adhesives | R 47710 | Yes | No |
| Capital Adhesives | R 79205 | Yes | No |
| G.F.E. Supply | AD2-4511-2 | Yes | No |
| Adhesive Products | 74EKJ | No | Yes |
| Adhesive Products | 74GCY | No | Yes |
| Capital Adhesives | HM 1123S | No | Yes |
| Capital Adhesives | HM 6105PI | No | Yes |
| Capital Adhesives | HM 6403PI | No | Yes |
| Capital Adhesives | HM 6113PE | No | Yes |
| Capital Adhesives | HM 8105 | No | Yes |

GLUE MANUFACTURERS

The products covered in the following specification sheets are manufactured by:

| | |
|--|--------------|
| The Adhesive Products, Inc. (API) | |
| 520 Cleveland Avenue, Albany, CA 94710 | 510-526-7616 |
| 4727 East 48 th Street, Los Angeles, CA 90058 | 213-589-5516 |
| 945 South Doris Street, Seattle, WA 98108 | 206-762-7459 |

| | |
|---|--------------|
| Capital Adhesives and Packaging Corporation | |
| 1260 OLD ST. RD. 67S, Moorsville, IN 46158 | 317-834-5415 |

| | |
|---|--------------|
| G.F.E. Supply, Inc. | |
| P.O. Box 10064, Fairfield, New Jersey 07004 | 973-808-1283 |

Fugitive glues for mailers (limited bond strength reducing fiber tear)

| Manufacturer | Part # | Description |
|--------------------------------------|---------|--------------------------------------|
| Adhesive Products | 1001 | Water based resin emulsion |
| Adhesive Products | 1006 | Water based resin solution |
| Capital Adhesives and Packaging Corp | HM 231 | Hot melt adhesive |
| Capital Adhesives and Packaging Corp | L 179 | Formulated latex emulsion |
| Capital Adhesives and Packaging Corp | L 17910 | Formulated latex emulsion |
| Capital Adhesives and Packaging Corp | R 90310 | Formulated resin emulsion |
| Capital Adhesives and Packaging Corp | R90506 | Formulated resin emulsion |
| Capital Adhesives and Packaging Corp | HM 150 | Hot melt fugitive pressure sensitive |

Permanent glue for packaging (strong bond strength)

| Manufacturer | Part # | Description | Purpose |
|-------------------|------------|-------------------------------------|--|
| Adhesive Products | 2173 | Water based resin emulsion | Folding carton |
| Capital Adhesives | HM 231 | Hot melt adhesive | Tipping and inserting |
| Capital Adhesives | R40603 | Formulated copolymer adhesive | Folding carton |
| Capital Adhesives | R42903 | Formulated copolymer adhesive | Aqueous coatings |
| Capital Adhesives | R47703 | Formulated copolymer adhesive | Polyboard app. |
| Capital Adhesives | R 47710 | Formulated resin emulsion | Poly board, aqueous coated SBS board stock, and other difficult paper stock and coatings |
| Capital Adhesives | R 79205 | Formulated resin emulsion | Varnished, coated and other difficult substrates, meets FDA Regulation 175.105 |
| G.F.E. Supply | AD2-4511-2 | Modified vinyl-acetate, water-based | Folding carton |

SPECIFICATIONS

Specifications:

GENERAL

| | |
|-----------------------------|---|
| CHANNELS | 2 |
| EVENTS PER CHANNEL | 4 |
| OUTPUTS PER CHANNEL | 4 |
| OPTICAL SENSOR INPUTS | 4 |
| ROTARY ENCODER INPUTS | 2 |
| SHUTTER CONTROL OUTPUT | 1 |
| BATCH KICKER OUTPUT | 1 |
| HOT MELT PUMP OUTPUT | 1 |
| PROPORTIONAL CONTROL OUTPUT | 1 |



ELECTRICAL DATA

| | |
|-------------------------|------------------------|
| INPUT POWER | 90 to 264 VAC |
| INPUT FREQUENCY | 47 to 440 Hz |
| GLUE VALVE OUTPUT | 2.5 MAX Output current |
| SHUTTER CONTROL OUTPUTS | 12 VDC, 100 watts |
| BATCH KICKER OUTPUT | 12 VDC, 100 watts |
| PROPORTIONAL CONTROL | 0 to 10 VDC, |

PROGRAMMING SPECIFICATIONS

| | |
|--------------------------|---|
| PROGRAMMING RESOLUTION | .01 inch, .1 mm |
| MAXIMUM GLUE LINE LENGTH | 100 inch, 2540 mm |
| MAXIMUM PRODUCT LENGTH | 100 inch, 2540 mm |
| ACCURACY | .01" at 1,000 ft/min, .3mm at 500 m/mm. |
| PURGE FREQUENCYS | 25Hz |
| MAXIMUM PRODUCT IN QUEUE | 10 pieces between optical sensor and glue valve |

DIMENSIONS

| | |
|--------------|-------------------------------------|
| SIZE (HxLxW) | 13.250inch x 8.187inch x 3.025 inch |
| WEIGHT | 5.6 lbs, |

ENCODER—

| | |
|-------------------|----------------------------|
| OPERATING VOLTAGE | +5 VDC |
| RESOLUTION | 500 pulses per revolution |
| SPRING MECHANISM | Internal bi-directional |
| DESIGN | Ultra compact |
| FRICTION WHEEL | Urethane |
| CABLE | 12' with modular connector |

2 GALLON STAINLESS STEEL TANK—

| | |
|------------|--|
| AIR SUPPLY | Up to 120 psi at 1 cubic foot per minute |
| CAPACITY | 2 gallons |
| TANK | Corrosion resistant wetted parts |

5 GALLON STAINLESS STEEL TANK—

| | |
|------------|--|
| AIR SUPPLY | Up to 120 psi at 1 cubic foot per minute |
| CAPACITY | 5 gallons |
| TANK | Corrosion resistant wetted parts |

BASIC TROUBLESHOOTING

I. If the head operates but glue is not consistent, not of adequate volume, or is not exiting straight—

- Check for glue in the tank.
- Check for a plugged filter.
- Check for additional shut off valves.
- Purge the line completely.
- Clean the nozzle tip on the head.
- Make sure the glue is not past its shelf life.
- Make sure the glue has been stored correctly (temperature range and sealed).
- Make sure the glue is at a proper working temperature.
- Clean, clean, clean the glue delivery system from the entry of the tank to the tip of the valve.
- Check the encoder for slipping if the glue position is inconsistent.
- Check the opto for its settings if the glue position is inconsistent.

II. Use the following question list for most other problems. If the answer to the question is YES, go to the next number, otherwise go through the bulleted list. Refer to the list (III) following these questions for specific problems with possible solutions.

1. Is the display lit?
 - Check the on/off switch on the back of the unit.
 - Check the power cord to the wall outlet.
 - Check the fuse in the power supply.
 - Unplug all cables on the back to check for a shorted device (head, opto, encoder, etc.)
2. Does the glue valve operate on and off with the purge button?
 - Check to make sure the shutters LED is on (units with shutters installed).
 - Check to see that the cable to the valve fully plugged in at each end.
 - On valves with stroke adjustment make sure the adjustment is not set to 0.
3. Does the display blank when an output goes active?
 - Check for a shorted device by unplugging the heads and trying again.
 - Try plugging the device into a different output.
4. Does glue exit the valve when the purge is operated?
 - Make sure that there is adequate pressure going to the glue tank.
 - Make sure the regulator on the glue tank is set high enough.
 - Check to see that the ON/OFF valve is in the on position.
 - Check to see that the filter is clean.
 - Make sure the lines to the head are clean (glue should flow freely if the line is removed at the head).
 - Make sure the head itself is clean (remove the nozzle and check for flow).
 - Make sure the glue is warm enough and the viscosity is low enough to operate.
5. Is the machine speed indicated on the display?
 - Check the encoder to be sure it is turning with the machine.
 - Check to see that the encoder cable is plugged in.
 - Check for damage to the encoder cable.
 - Check for damage at the encoder itself.
6. Is there a job programmed?
 - Program a job.
7. Is (are) the output(s) enabled?
 - Enable the output.

8. Are the shutters opened?
 - Check the cutoff speed compared to the displayed machine speed.
 - Check the encoder to make sure it is turning with the machine.
 - Check the cable on the encoder.
9. Is the opto tripping?
 - Check the position and setting of the opto sensor.
 - Check for an unplugged cable.
 - Check for a damaged opto cable or opto sensor.
10. Is the cable connected to the head?
 - Unplug and plug the connectors at each end of the cable to insure good connections.
11. Is the head electrically operating with the purge button (making noise)?
 - Check for a pattern that is too short to operate reliably.
 - Try a different output or a different channel.
 - Replace the head or the control box.
12. Is there pressure in the glue tank?
 - Check the high pressure air connection.
 - Is the regulator set correctly?
13. Is there glue at the line entering the head?
 - Check for glue in the tank.
 - Open the valve on the outlet side of the tank and any additional in-line valves.
 - Check for a plugged filter.
14. Is there glue flow if the hose is removed at the head?
 - Check for glue in the tank.
 - Open the valve on the outlet side of the tank and any additional in-line valves.
 - Check for a plugged filter.
 - Check for poor quality or contaminated glue.
15. Is the glue skipping sheets, applying twice on a sheet, or operating randomly?
 - Check the product length to make sure the unit will not trip on a window or printing.
 - Check the product length to make sure the opto can trip by the next sheet.
 - Check for enough gap between sheets to allow the opto to respond.
 - Check the encoder to make sure it is turning consistently at the product speed.
 - Make sure the product is not slipping on the machine.
 - Make sure the opto lead value is correct.
 - Verify the on and off compensation times. Incorrect times will cause pattern shift with speed changes.
 - Check for a plugged or dirty nozzle (filter, glue lines, etc.).
 - Check for inadequate glue pressure from the tank and regulator.
 - Check for glue wiping off on machine parts (causing a myriad of possible problems).
 - Check for glue being squeezed out of position (generally pushed down the sheet).
16. Is the glue volume incorrect or inconsistent?
 - On valves with stroke adjustment, change the stroke. On all valves the nozzle size can be changed.
 - Check for correct tank pressure.
 - Check for a dirty nozzle or filter/line contamination.
 - Check for dirty glue.
 - Incorrect roller pressure can cause squeeze problems on the glue. This can also cause pattern shift.

III. The following is a list of possible problems with their possible causes—

1. The opto lead is incorrect when measured by the hand feeding method.
 - The encoder was moved or flexed backwards during the move.
 - The encoder is not turning at the same rate as the paper is moving.
 - Speed is too low on the conveyor.
 - In folding, the roller groove is too narrow (pressure spreads the glue bead).
2. Glue volume is too high.
 - Too much glue pressure.
 - Too large a nozzle in the glue.
3. The glue is splattering on the sheet.
 - Too much glue pressure.
 - Air in the glue line.
4. The glue volume is too low (or not at all).
 - Too little glue pressure.
 - The filter is plugged or dirty.
 - The glue quality is not good (out of date, or improperly stored).
 - The glue is chilled and has become too thick.
 - The cutoff speed is higher than the machine speed.
 - The valve is operating for too short of a time. The minimum on time (or frequency) needs to be adjusted.
5. The glue beads up on the tip of the valve.
 - Too little glue pressure and the glue is not escaping the head during turn off.
 - Contamination in the glue.
 - The head is too close to the paper.
 - Too much pressure and the glue is bouncing back from the sheet to the valve.
6. The valve does not operate.
 - The machine is not above the cutoff speed.
 - The opto is not being tripped by the paper.
7. Glue occurs every other sheet instead of every sheet.
 - The product length is too long.

Note that too short a product length on printed or windowed sheet may cause extra patterns on the same sheet. Starting the job while the opto sensor is in the middle of a printed or windowed sheet may cause the pattern to be offset.
8. The glue pattern is moving around on the sheet.
 - The encoder is slipping.
 - The encoder is not turning at the same speed as the paper.
 - The paper is slipping or moving on the machine.
9. The dot (or gap) size is wrong.
 - The machine speed is too great and the unit has shifted into time mode. Reduce the speed or enlarge the dot (gap) size.
10. The speed is not shown in the display.
 - The encoder is not physically connected to the machine.
 - The encoder is not plugged into the unit.
11. The display is not counting.
 - The opto is not set correctly—check the opto indicator light on the unit.
 - The opto is not plugged into the unit.
12. The pressure in the glue tank cannot be adjusted or adjusts poorly.
 - Glue has gotten into the regulator. Clean (or soak in water) the glue from the regulator. Avoid moving the tank in a manner that will allow glue to contaminate the regulator in the future.

SERVICE AND SUPPORT

We are here to provide the support you need every business day.

Please call 8:00 AM to 5:00 PM Pacific Standard Time any weekday, excluding holidays. We are eager to do all that is possible to resolve field issues over the phone, minimize down time and maximize productivity.

When calling for service, please have this manual on hand and the serial number from the back of the display console to help us resolve your concerns expeditiously.

If factory service is required, please photocopy and complete the return form on the following page, then contact us for specific return directions.

REPAIR RETURN AUTHORIZATION SHEET

RMA #

| | | | | | |
|-----------------------|--|------------|--|-----|--|
| SENDER | | | | | |
| Company | | | | | |
| Street | | | | | |
| City | | State | | Zip | |
| Phone Number | | Fax Number | | | |
| Contact name | | | | | |
| Purchase Order Number | | | | | |

| List all parts being shipped | Serial numbers |
|------------------------------|----------------|
| | |
| | |

| | |
|-----------------------|--|
| Symptoms/Instructions | |
| | |
| | |

| | |
|---|--|
| X | Mark <u>one</u> for preferred return shipping method |
| | 8 hour air courier (US only) |
| | Next business day delivery |
| | Saturday delivery |
| | 2 day service |
| | 3 day service |
| | Ground delivery service |

*All repairs **MUST** be accompanied by this sheet. Only repairs shipped overnight, or couriered, and received by 10:30 AM are eligible for same day repair.*

GMS
1310 Redwood Way, Suite B.
Petaluma CA 94954 USA
Phone: 707 285-3392 FAX: 707 285-3399
e-mail: sales@microglue.com

Signed _____

DECLARATION BY THE MANUFACTURER

(Directive 89/392/EEC, Art. 4.2 and Annex II, sub B)

GMS, 1310 Redwood Way, Suite B., Petaluma, CA, USA herewith declares that the product covered by this instruction manual is intended to be incorporated into machinery or to be assembled with other machinery to constitute machinery covered by Directive 89/392/EEC, as amended and that the following (parts/clauses of) harmonized standards and national technical standards have been applied:

EN 50082-2: 1995 “Electromagnetic Compatibility – Generic Immunity Standard, Part 2: Industrial Environment”

CISPR 22: “Limits and Methods of Measurement of Radio Interference Characteristics of Information Technology Equipment”

FCC Part 15 stating: “This device complies with Part 15 of the FCC Rules. Operation is subject to the following two conditions: (1) this device may not cause harmful interference, and (2) this device must accept any interference received, including interference that may cause undesired operation.”

FCC warning stating: “Changes or modification not expressly approved by the party responsible for compliance could void the user’s authority to operate this equipment.”

ISO/IEC Guide 25 in the category of “Electrical (EMC)”, including in its scope the EMC standard AS/NZ 3548 under the authority of the A2LA and NATA laboratory accreditation agreement.

Class A warning requirement that “This is a class A product. In a domestic environment this product may cause radio interference” in which case the user may be required to take adequate measures.

The Japanese standard for “Voluntary Control Council for Interference (VCCI) by Data Processing Equipment and Electronic Office Machines, Technical Requirements” which is technically equivalent to CISPR 22 (1993).

WARRANTY POLICY

GMS® warrants that products manufactured by it shall be free of defects in material and workmanship when operated in accordance with GMS's operating and maintenance procedures for one year following from the date of invoice:

GMS's liability is limited to the repair or replacement, of any product which proves to be defective during the warranty period outlined. The product must be returned, prepaid by purchaser, to GMS after obtaining a Return Authorization Number from GMS. GMS shall have the right of final determination as to the existence and cause of any defects.

This warranty shall not cover unauthorized repairs, alterations, modifications, or use by the purchaser of product for which it is not intended without prior written consent from GMS.

GMS hot and cold glue valves contain parts which are considered consumables and are not covered under warranty unless deemed defective at the point of sale.

This warranty shall not cover abuse, neglect, improper operating or maintenance procedures, voluntary or involuntary damages of the product by the purchaser.

GMS's liability under this warranty shall in no event exceed the purchase order price and shall not cover any losses caused by delays or for any expenses for labor, supplies, machine rental or loss or damages to other property.

No warranty is made with respect to customer equipment or products manufactured to purchaser's specifications except as specifically stated in writing by GMS.

GMS assumes no responsibility for the quality or performance of coatings, adhesives, or other customer supplied materials used with GMS's equipment.

GMS's responsibility for transportation under this warranty is limited to charges for delivery of repaired products via the least expensive transportation available, to the purchaser in the Continental United States only. Alternative methods of shipping will be prepaid for solely by the customer. Payment for shipment of GMS parts or products to GMS's facilities is the responsibility of the purchaser.

Warranty for items that are repaired or replaced by GMS shall continue in effect for the remainder of the original warranty period or for ninety (90) days following the date of shipment by GMS, whichever period is longer.

This warranty supersedes any other warranty, expressed or implied, and constitutes all of Gluing Machinery & Systems, Inc.'s liability with respect to its products.

This warranty is non-transferable.

